

HEXFRED® Ultrafast Soft Recovery Diode, 240 A

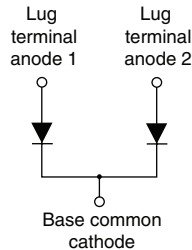

TO-244

FEATURES

- Very low Q_{rr} and t_{rr}
- Lead (Pb)-free
- Designed and qualified for industrial level

**RoHS
COMPLIANT**
BENEFITS

- Reduced RFI and EMI
- Reduced snubbing

DESCRIPTION

HEXFRED® diodes are optimized to reduce losses and EMI/RFI in high frequency power conditioning systems. An extensive characterization of the recovery behavior for different values of current, temperature and di/dt simplifies the calculations of losses in the operating conditions. The softness of the recovery eliminates the need for a snubber in most applications. These devices are ideally suited for power converters, motors drives and other applications where switching losses are significant portion of the total losses.

PRODUCT SUMMARY

$I_{F(AV)}$	240 A
V_R	400 V
$I_{F(DC)}$ at T_C	197 A at 100 °C

ABSOLUTE MAXIMUM RATINGS

PARAMETER	SYMBOL	TEST CONDITIONS	MAX.	UNITS
Cathode to anode voltage	V_R		400	V
Continuous forward current	I_F	$T_C = 25\text{ °C}$	395	A
		$T_C = 100\text{ °C}$	197	
Single pulse forward current	I_{FSM}	Limited by junction temperature	900	
Non-repetitive avalanche energy	E_{AS}	$L = 100\text{ }\mu\text{H}$, duty cycle limited by maximum T_J	1.4	mJ
Maximum power dissipation	P_D	$T_C = 25\text{ °C}$	658	W
		$T_C = 100\text{ °C}$	263	
Operating junction and storage temperature range	T_J, T_{Stg}		- 55 to + 150	°C

ELECTRICAL SPECIFICATIONS ($T_J = 25\text{ °C}$ unless otherwise specified)

PARAMETER	SYMBOL	TEST CONDITIONS	MIN.	TYP.	MAX.	UNITS	
Cathode to anode breakdown voltage	V_{BR}	$I_R = 100\text{ }\mu\text{A}$	400	-	-	V	
Maximum forward voltage	V_{FM}	$I_F = 120\text{ A}$	-	1.1	1.47		
		$I_F = 240\text{ A}$	See fig. 1	-	1.3		1.5
		$I_F = 120\text{ A}, T_J = 125\text{ °C}$		-	1.0	1.2	
Maximum reverse leakage current	I_{RM}	$T_J = 125\text{ °C}, V_R = 400\text{ V}$	See fig. 2	-	660	5000	μA
Junction capacitance	C_T	$V_R = 200\text{ V}$	See fig. 3	-	280	380	pF
Series inductance	L_S	From top of terminal hole to mounting plane	-	6.0	-	nH	

DYNAMIC RECOVERY CHARACTERISTICS ($T_J = 25\text{ }^\circ\text{C}$ unless otherwise specified)						
PARAMETER	SYMBOL	TEST CONDITIONS	MIN.	TYP.	MAX.	UNITS
Reverse recovery time See fig. 5	t_{rr}	$I_F = 1.0\text{ A}$, $di_F/dt = 200\text{ A}/\mu\text{s}$, $V_R = 30\text{ V}$	-	50	-	ns
		$T_J = 25\text{ }^\circ\text{C}$	-	77	120	
		$T_J = 125\text{ }^\circ\text{C}$	-	290	440	
Peak recovery current See fig. 6	I_{RRM}	$T_J = 25\text{ }^\circ\text{C}$	-	7.5	14	A
		$T_J = 125\text{ }^\circ\text{C}$	-	16	30	
Reverse recovery charge See fig. 7	Q_{rr}	$T_J = 25\text{ }^\circ\text{C}$	-	290	780	nC
		$T_J = 125\text{ }^\circ\text{C}$	-	2300	6300	
Peak rate of recovery current See fig. 8	$di_{(rec)M}/dt$	$T_J = 25\text{ }^\circ\text{C}$	-	320	-	A/ μs
		$T_J = 125\text{ }^\circ\text{C}$	-	270	-	

THERMAL - MECHANICAL SPECIFICATIONS						
PARAMETER	SYMBOL	MIN.	TYP.	MAX.	UNITS	
Maximum junction and storage temperature range	T_J, T_{Stg}	- 55	-	150	$^\circ\text{C}$	
Thermal resistance, junction to case	R_{thJC}	per leg	-	-	0.19	$^\circ\text{C}/\text{W}$
		per module	-	-	0.095	
Typical thermal resistance, case to heatsink	R_{thCS}	-	0.10	-		
Weight		-	68	-	g	
		-	2.4	-	oz.	
Mounting torque	(1)	30 (3.4)	-	40 (4.6)	N · m (lbf · in)	
	center hole	12 (1.4)	-	18 (2.1)		
Terminal torque		30 (3.4)	-	40 (4.6)		
Vertical pull		-	-	80	lbf · in	
2" lever pull		-	-	35		

Note

(1) Mounting surface must be smooth, flat, free of burrs or other protrusions. Apply a thin even film of thermal grease to mounting surface. Gradually tighten each mounting bolt in 5 to 10 lbf · in steps until desired or maximum torque limits are reached.



HEXFRED®
Ultrafast Soft Recovery
Diode, 240 A

Vishay High Power Products

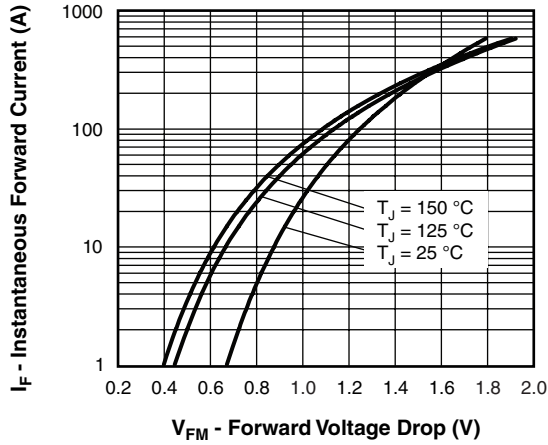

Fig. 1 - Maximum Forward Voltage Drop vs. Instantaneous Forward Current (Per Leg)

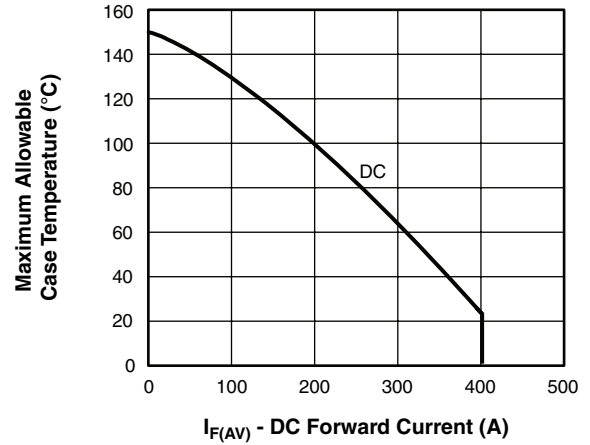

Fig. 4 - Maximum Allowable Case Temperature vs. DC Forward Current (Per Leg)

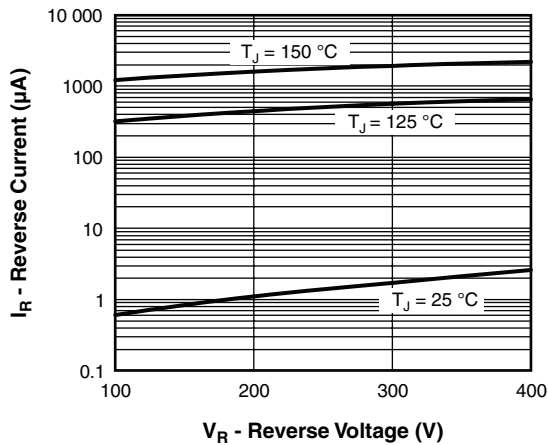

Fig. 2 - Typical Reverse Current vs. Reverse Voltage (Per Leg)

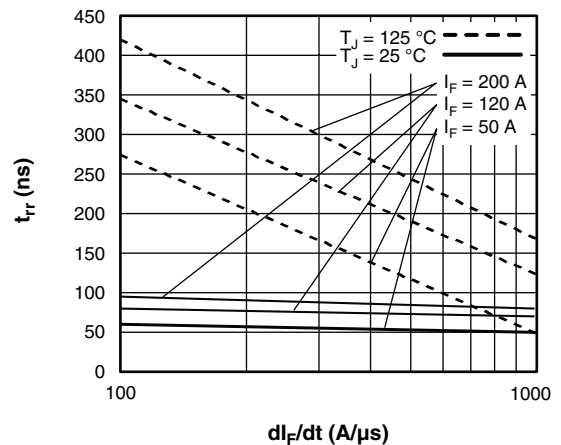

Fig. 5 - Typical Reverse Recovery Time vs. di_F/dt (Per Leg)

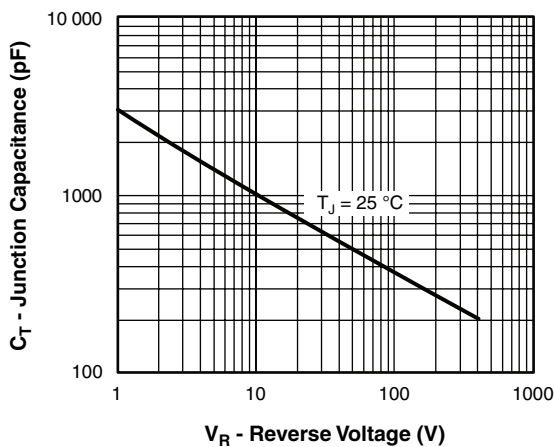

Fig. 3 - Typical Junction Capacitance vs. Reverse Voltage (Per Leg)

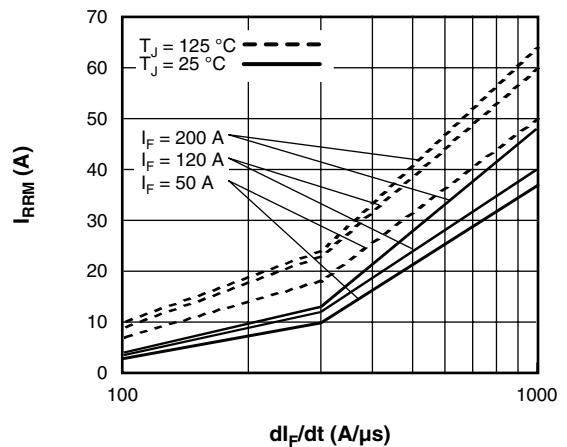

Fig. 6 - Typical Recovery Current vs. di_F/dt (Per Leg)

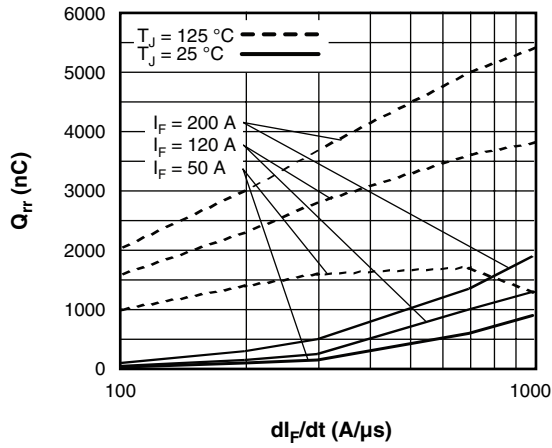

Fig. 7 - Typical Stored Charge vs. dI_F/dt (Per Leg)

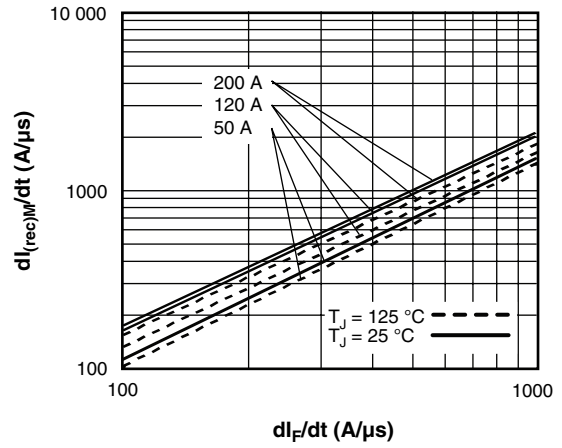

Fig. 8 - Typical $dI_{(rec)M}/dt$ vs. dI_F/dt (Per Leg)

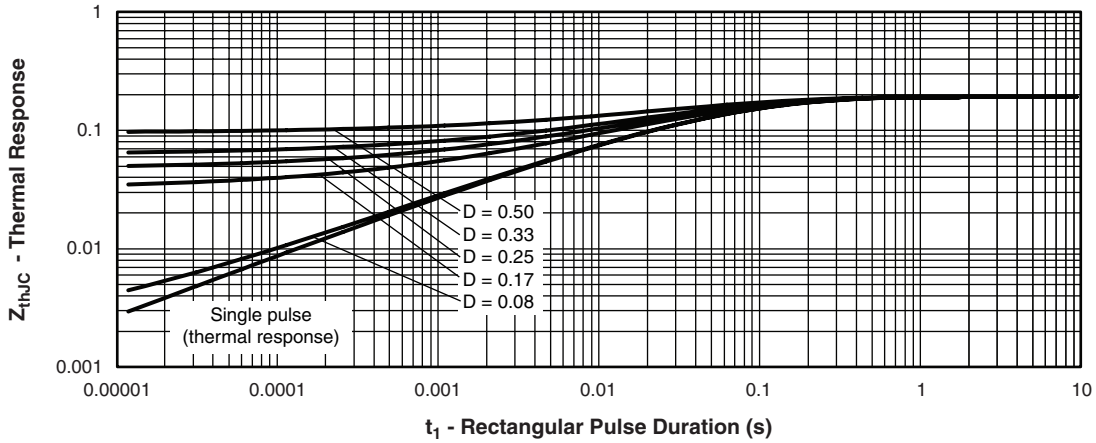

Fig. 9 - Maximum Thermal Impedance Z_{thJC} Characteristics (Per Leg)

HEXFRED® Ultrafast Soft Recovery Diode, 240 A

Vishay High Power Products

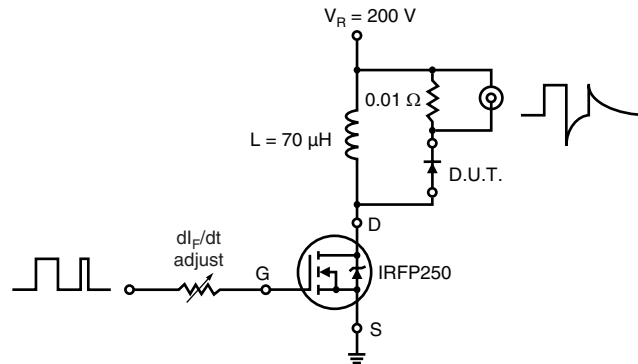
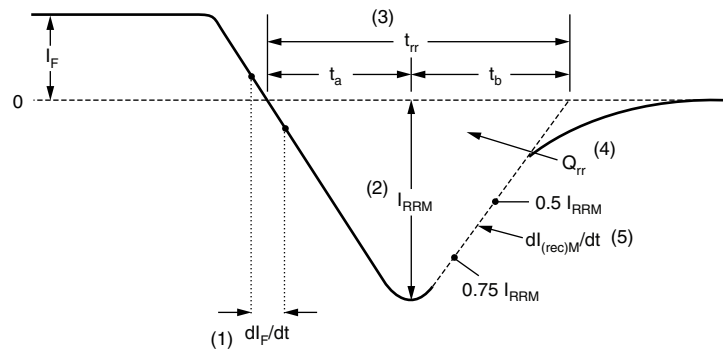

Fig. 10 - Reverse Recovery Parameter Test Circuit



(1) di_F/dt - rate of change of current through zero crossing

(2) I_{RRM} - peak reverse recovery current

(3) t_{rr} - reverse recovery time measured from zero crossing point of negative going I_F to point where a line passing through $0.75 I_{RRM}$ and $0.50 I_{RRM}$ extrapolated to zero current.

(4) Q_{rr} - area under curve defined by t_{rr} and I_{RRM}

$$Q_{rr} = \frac{t_{rr} \times I_{RRM}}{2}$$

(5) $dl_{(rec)M}/dt$ - peak rate of change of current during t_b portion of t_{rr}

Fig. 11 - Reverse Recovery Waveform and Definitions

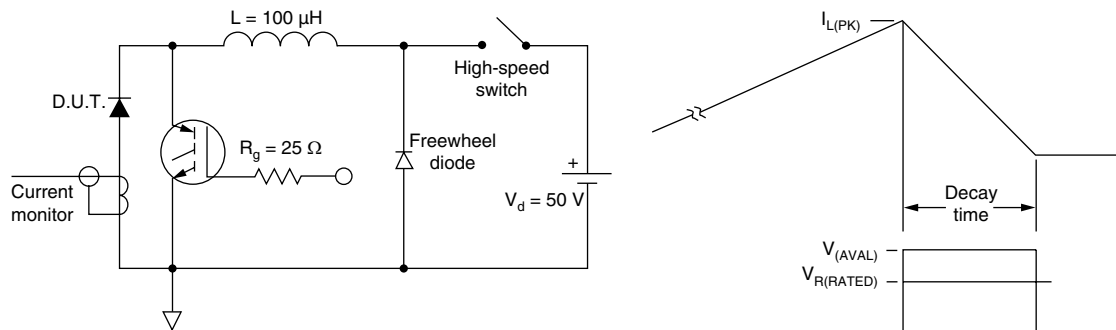

Fig. 12 - Avalanche Test Circuit and Waveforms

HFA240NJ40CPbF

Vishay High Power Products

HEXFRED®
Ultrafast Soft Recovery
Diode, 240 A



ORDERING INFORMATION TABLE

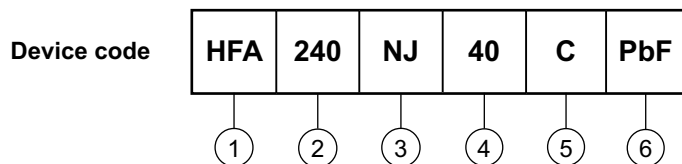

- 1** - HEXFRED® family, electron irradiated
- 2** - Average current rating
- 3** - NJ = TO-244
- 4** - Voltage rating (400 V)
- 5** - C = Common cathode
- 6** - Lead (Pb)-free

LINKS TO RELATED DOCUMENTS	
Dimensions	http://www.vishay.com/doc?95021



Disclaimer

All product specifications and data are subject to change without notice.

Vishay Intertechnology, Inc., its affiliates, agents, and employees, and all persons acting on its or their behalf (collectively, "Vishay"), disclaim any and all liability for any errors, inaccuracies or incompleteness contained herein or in any other disclosure relating to any product.

Vishay disclaims any and all liability arising out of the use or application of any product described herein or of any information provided herein to the maximum extent permitted by law. The product specifications do not expand or otherwise modify Vishay's terms and conditions of purchase, including but not limited to the warranty expressed therein, which apply to these products.

No license, express or implied, by estoppel or otherwise, to any intellectual property rights is granted by this document or by any conduct of Vishay.

The products shown herein are not designed for use in medical, life-saving, or life-sustaining applications unless otherwise expressly indicated. Customers using or selling Vishay products not expressly indicated for use in such applications do so entirely at their own risk and agree to fully indemnify Vishay for any damages arising or resulting from such use or sale. Please contact authorized Vishay personnel to obtain written terms and conditions regarding products designed for such applications.

Product names and markings noted herein may be trademarks of their respective owners.